

Power Measurements

Handheld Site Master™/VNA Master™/Spectrum Master™/
BTS Master™/Cell Master™ products

Introduction

Anritsu’s handheld Site Master, Cell Master, BTS Master, Spectrum Master, and VNA Master products provide a wide range of modes and options for power measurements including the High Accuracy Power Meter, the Internal Power Meter, the External Power Monitor, and the Channel Scanner. Each Power Meter solution has its own unique strengths and benefits. The objective of this application note is to discuss the basics of these different power meter solutions and to explain how Anritsu’s handheld products can be used to make power meter measurements for different applications.

The first section of this application note covers the basics of power measurements. Why is accuracy important? Common features for the different modes such as Zeroing, Relative Power Measurements, Averaging, and Offset will be discussed here.

The next section of the application note will provide details about each power meter solution and also provide details and procedures describing how to make the measurement for specific modes.

The S331D, S332D, S810D, S820D, MS2711D, and MT8212B products are referred to as the D-platform. The MS2721B, MS2723B, MS2724B, MS2024A, MS2026A, MS2034A, and MS2036A products belong to the Super-H platform.



What is Power

Power is used in different applications and is defined as the rate of energy transfer. The SI unit of power is Watt, which is equal to 1 Joule per second. In the electrical world, $P=V \cdot I$ or $P=V^2/R$ are common relationships used to obtain the instantaneous power.

Units

Anritsu's handheld power meter solutions display power both logarithmically in dBm and linearly in milliWatt (mW).

$$\text{Power (dBm)} = 10 \text{ Log Power (mW)}$$

$$\text{Power (mW)} = 10^{\text{Power (dBm)/10}}$$

For example, 23 dBm is equal to 200 mW ($10^{23/10}$) and 2000 mW or 2W is equal to 33 dBm ($10 \text{Log} 2000$).

Relative Power

The relative power feature available in all the power meter solutions display the relative power with respect to a desired base power level input. It can be very practical if you have a need to compare two or more signals. For instance, if a 10 dBm signal is measured and the relative power key is pressed, the relative power level will show 0 dB (assuming the power level is still 10 dBm). If the power then is increased to 13 dBm, the relative power will show 3 dB.

The relative power level is displayed in percentage if the unit is in Watt before the relative key is selected. For example, the relative power would read 100% right after the relative key is pressed if the power is the same as before. A 3 dB increase from 10 dBm to 13 dBm would show up as 200%. Similarly, a 3 dB drop would show up as 50% according to the 3 dB rule (3 dB increase equals to twice as much power and 3 dB decrease equals to half the power).

To convert from relative power changes in dB to percentage and vice versa, use the following relationships.

$$10^{(\text{Current Power}/10 - \text{Reference Power}/10)} = \text{Relative Power (\%)}$$

$$\text{Relative Power (dB)} = 10 \text{ Log (Relative Power (\%)/100)}$$

A relative power value of 70% equals to -1.55 dB ($10 \text{ Log } 0.7$).

Zero the sensor

The Power Monitor and the High Accuracy Power Meter modes have the ability to zero the detector and the sensor. The zero value or the measured power with no RF applied to the sensor can sometime change over time and with temperature. It is a good practice to zero the sensor before making any power measurements to remove any inaccuracies as a result of the quiescent power. In particular, it will improve the accuracy for lower level signals. The duration of the zero calibration varies depending on the mode. The zero process is performed with nothing connected to the sensor. The zero calibration process should be reapplied if the temperature is changing.

Calibration Factor

The overall ratio of incident power to the power absorbed in the detection element is called the calibration factor. It is a function of the less than ideal match between the sensor and the cal factor calibration system. The cal factor is frequency dependent and entering the frequency in the High Accuracy Power Meter mode and in the Internal Power Meter will correct any errors as a result of the cal factor uncertainty.

Offset

The offset feature allows you to take into account any attenuators or cables connected to the sensor or receive power port for the high accuracy power meter, power monitor, channel scanner, and internal power meter.

For instance, it is common practice to connect a 30 dB attenuator to the power meter head when making measurements at a base station that is outputting +43 dBm. Without the offset feature, the power on the display would show +13 dBm. If you press offset and enter 30 dB, the power will read +43 dBm.

Offset Calibration

The offset calibration feature should be used to minimize error contributions of the attenuator and the phase stable cable. For instance, if you are using the internal power meter mode, a phase stable cable and an attenuator is usually connected to the output of the base station or output of the device that you are trying to measure. The combination of the cable and attenuator affects the loss and will most likely not be the same as the specified value of the attenuator. The attenuator loss can vary a little bit from cable to cable and the loss of the cable will vary depending on what cable you are using and the length of the cable. To minimize the errors of the cable/attenuator assembly, it is a good practice to perform an offset calibration.

The cable/attenuator is characterized over the entire frequency range (25 MHz to 3 GHz) and the instrument automatically subtracts the offset for the selected frequency range. This calibrated offset is automatically turned off when the unit is turned off or when the mode is changed. It is possible to recall the last offset cal.

This calibration is available in the Spectrum Analyzer, Channel Scanner, Power Monitor, Power Meter, and High Accuracy Power Meter for the S33XD, MS2711D, and MT8212B products. Kit 65701 is required for the offset calibration. It includes an 18" (46 cm) cable and a 10 dB pad.

Averaging

Averaging is used to obtain the average of several measurements. You can set the number of averages you like to perform. If the signal level is varying, increasing the number of averages can improve the stability of the reading. Averaging is available in all the different power solutions for all the handheld products. Regardless of the unit selection prior to turning on averaging, the computation will always be performed using the linear power.

Modulated Signals

Increasing data demands in the industry is changing the modulation type used in today's communication systems. It is no longer enough to have the ability to measure the power of constant amplitude modulation schemes such as FM signals. Digitally complex signals such as CDMA, WCDMA, GSM/GPRS, and Wi-MAX add complexity to the power measurement testing. These signals can have large crest factors (ratio of peak and average power in dB) and a 10-12 dB peak to average power ratio is common for Quadrature Amplitude Modulated (QAM) signals. This amplitude variation puts a constraint on the power meter solutions that can be used to obtain accurate power measurements.

The conventional CW diode detector is no longer the best choice for these types of measurements using complex modulation schemes. A true RMS sensor is needed to measure the channel power of digitally modulated signals accurately.

Dedicated options mode for WCDMA/HSDPA, CDMA/EV-DO, WiMAX, GSM/EDGE/GPRS should be used if more information than the channel power is needed.

An EDGE signal with four slots on instead of eight will provide an average power that is 3 dB lower than the burst power. The channel power can be accurately measured with the power meter solutions but in order to measure the average burst power correctly, the GSM/EDGE/GPRS option should be used.



Figure 1. Calibration Kit 65701

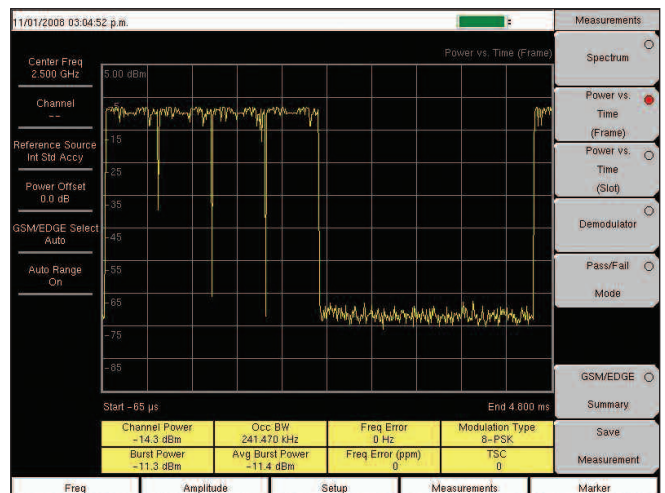

Figure 2. EDGE Burst with 4 slots on using the GSM/EDGE/GPRS option

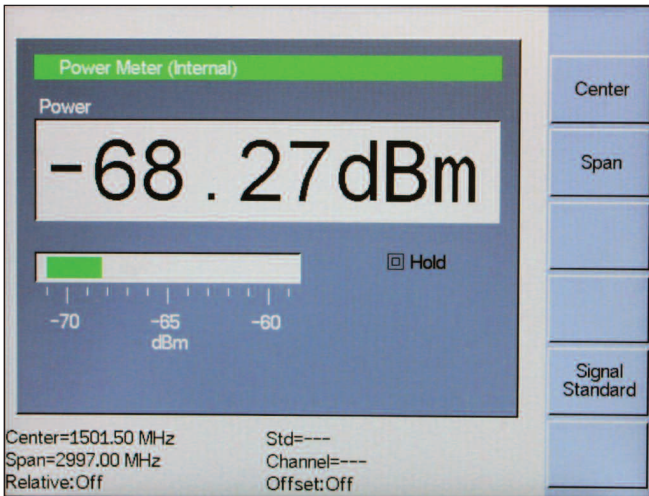

Figure 3. GSM signal with 8 slots turned on.

Figure 3 shows how the GSM option in the MT8212B is used to measure the burst power and channel power of a GSM signal. Since all the 8 slots are on, the channel power is close to the same as the burst power.

If you have a need to obtain the crest factor and the data burst power in addition to the channel power when measuring an 802.16d signal, the Fixed WiMAX option is the ideal solution.

WCDMA signals can have large peak to average power. Figure 5 shows how the WCDMA/HSDPA RF measurement option is used to measure the channel power and peak to average power.

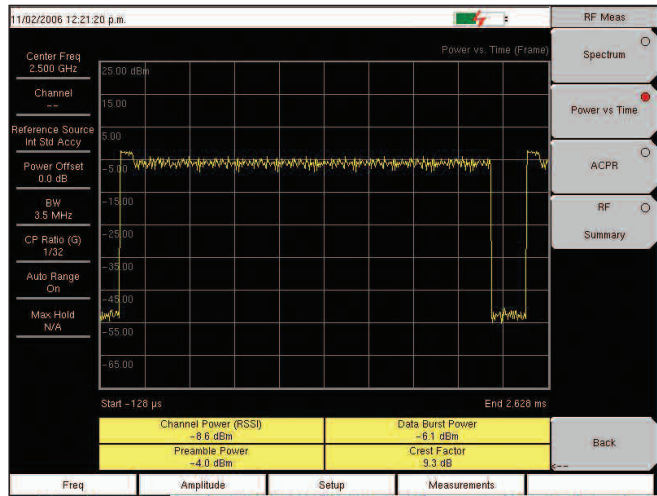

Figure 4. 64 QAM WiMAX using the WiMAX option

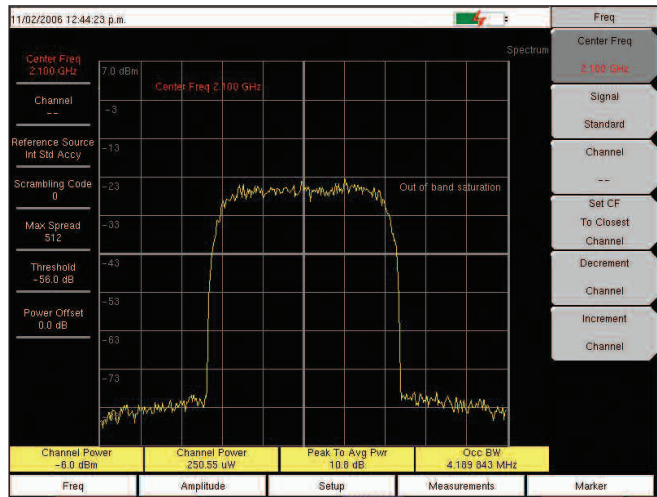

Figure 5. Channel and Peak-To-Average power of a WCDMA signal.

Why Accurate Power Measurements are needed

Depending on the application, the accuracy of the power meter solution could have a significant impact on the overall performance. For instance, let's assume your job is to verify the output power of a base station.

The output power transmitted at the base station affects the coverage area. When the BTS (Base Transceiver Station) is installed, the output power is measured and verified. System designers try to optimize the coverage area while balancing the trade-offs. More output power means better coverage area but it also leads to more interference. If the power output is below a minimum limit, the coverage will be reduced and this could eventually lead to dropped calls and dissatisfied customers. Needless to say, the accuracy of the power measurement is very important and can have a significant impact on the overall performance and on the end user.

If a base station operating at 900 MHz has an Effective Radiated Power (ERP) of +46 dBm and the receiver needs -55 dBm, the user needs to be 2976 m away from the transmitter to reduce the power to these levels if only the path loss is taken into consideration. A 1.5 dB error in the power measurement would give you an ERP of +47.5 dBm and the corresponding distance to achieve the same received power is now 3537 m or 18.8% greater. Assuming that the coverage area is proportional to the square of the distance then the 1.5 dB measurement error at the base station can correspond to a 41% error in coverage area.

In other words, because the power is at best inversely proportional to the square of the distance, small errors in power can result in large coverage errors.

High Accuracy Power Meter

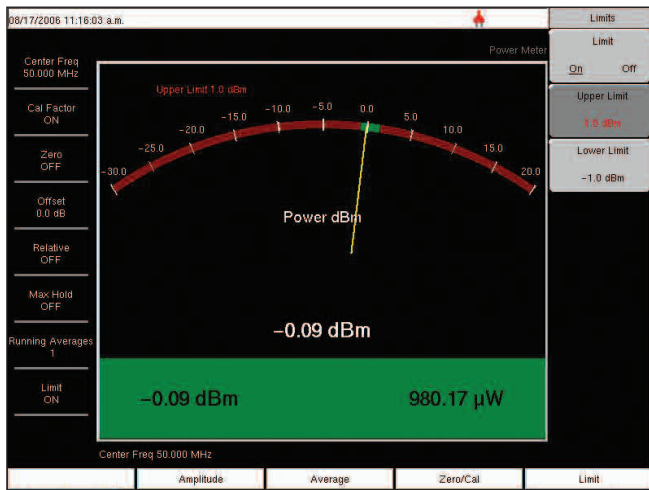

Figure 6. High Accuracy Power Meter display (MT8222A, MS272XB)



Figure 7. High Accuracy Power Meter display (S33XD, MT8212B, MS2711D)

The High Accuracy Power Meter in conjunction with the PSN50 sensor is designed to provide accurate measurements from 50 MHz to 6 GHz. The sensor provides true RMS measurements from -30 to +20 dBm and is the ideal solution for both CW and digitally modulated signals including WiMAX, GSM, EDGE, GPRS, CDMA, EV-DO, WCDMA, and HSDPA. It is designed to provide field users with a practical power meter solution for base station testing by delivering bench top accuracy to the field environment. Among all the different power solutions available, the High Accuracy Power Meter provides the most accurate measurements. It is strongly recommended for power measurements below 6 GHz where accuracy is of importance.

The PSN50 sensor is equipped with both a USB and serial port interface so that it will work for both the BTS Master (MT8222A) and the S331D/S332D/MT8212B/MS2711D products. The USB Host provides DC power for the sensor but a separate DC supply is needed for the RS232 interface. The standard Anritsu power supply works but since the current consumption is in the order of 80 mA, a battery supply can also do the job.

The High Accuracy Power Meter includes limit setup for PASS/FAIL measurements, averaging, offset, Max/Hold for frequency hopping signals, zero feature to remove system noise, and cal factor corrections to correct for efficiency and mismatch losses.

Base stations (BTS) typically output 20 W (43 dBm). Placing a 30 dB attenuator between the sensor and the DUT brings down the power level to 13 dBm. The upper measurement range of the sensor is +20 dBm and placing an attenuator in between the sensor and the DUT prevents the sensor from getting damaged and also ensures that measurements are made in the linear range. The standard offset feature can be used to measure the S21 of the attenuator accurately.

The total measurement accuracy of the High Accuracy Power Meter excluding VSWR is better than 0.16 dB from -30 to +16 dBm for both CW and modulated signals. Even signals with large peak to average ratio such as CDMA, WCDMA, and WiMAX can be measured accurately using the PSN50 sensor.



Figure 8. PSN50 High Accuracy Power Sensor

Procedure for the S331D/S332D/MT8212B/MS2711D

- Step 1. Connect the RS-232 serial cable between the High Accuracy Power Sensor and the Cell/Site/Spectrum Master.
- Step 2. Power the PSN50 sensor with power supply 40-168. Connect the DC supply to the DC input of the PSN50 sensor.
- Step 3. Press the **ON/OFF** key on the Cell/Site/Spectrum Master.
- Step 4. Press the **MODE** key. Use the Up/Down arrow key to select the High Accuracy Power Meter mode and press Enter.

Zero and Cal

- Step 5. Press **FREQ/DIST** key and select Center to enter the frequency manually using the number keys. Or Press the Signal Standard key and the up and down arrows to select a particular standard. The Cal Factors will be derived for the corresponding center frequency. (Channel number is not needed because the cal factor frequencies are rounded to the nearest 500 MHz).
- Step 6. With no power applied to the sensor, press the **AMPLITUDE** key then the Zero key to zero the sensor. This is recommended when making power measurements below -20 dBm.

Using Attenuators

- Step 7. Press the **AMPLITUDE** key and select the Offset dB key.
- Step 8. Connect any phase stable cable and the attenuator between the DUT and the sensor.
- Step 9. Enter the combined offset value of the attenuator and the pad. Or select Measure Offset to use kit 65701 to measure the offset. For more information about the Offset Cal, see page xx.

Averaging/Max Hold/Run Hold

- Step 10. Press the **MEAS/DISP** key.
- Step 11. Press the Running Averages key. Up to 50 averages can be entered. Use the key pad to enter the number of averages you would like to use.
- Step 12. Press the **Max Hold** key to display the maximum value. If averaging is selected, the Max/Hold will display the max value of the non-averaged data.
- Step 13. Press the **RUN/HOLD** key to hold the display in the current condition.

Limits

- Step 14. Press the **MEAS/DISP** key.
- Step 15. Press the Limit Units key to select the units you would like to use for entering the limits.
- Step 16. Press the Lower Limit key. Enter the lower limit value in dBm or in Watts.
- Step 17. Press the Upper Limit key. Enter the upper limit value in dBm or in Watts.
- Step 18. Press Limit **ON/OFF** key to turn on the limits. The number display will turn green or red if the measurement is passing or failing. The word PASS and FAIL will also be displayed in between the logarithmic and linear display windows.

Displaying Relative Power

- Step 19. Press the **AMPLITUDE** hard key.
- Step 20. With the desired base power level input to the sensor, press the Rel soft key. The Message area will show Relative On and the power reading will show 0 dB and 100%. If you are measuring a 10 dBm signal and the Rel key is selected, a drop to 7 dBm will show -3dB and 50%.

Saving the Measurement

- Step 21. Press the **SAVE DISPLAY** key.
- Step 22. Use the soft keys to enter a Trace Name.

Transferring to Handheld Software Tools

- Step 23. Disconnect the serial cable and connect it to Handheld Software Tools (HHST). There is only one serial port and it is not possible to communicate with HHST and the PSN50 sensor at the same time. As a result, it is not possible to Capture Current Data in HHST. Only saved files can be viewed in HHST.

Procedure for the MT8222A BTS Master and the MS272XB Spectrum Master

Turning on the BTS/Spectrum Master and the sensor

- Step 1. Connect the USB A/mini-B cable between the High Accuracy Power Sensor and the BTS Master.
- Step 2. Press the **ON/OFF** key on the BTS Master.
- Step 3. Press the **Mode** (Shift and Mode) key. Use the Up/Down arrow key to select the **High Accuracy Power Meter** mode and press Enter.

Zero and Cal

- Step 4. Press the **Zero/Cal** key and select **Cal Factor**. Enter the Center Frequency or Press the Signal Standard key and the up and down arrows to select a particular standard. The Cal Factors will be derived for the corresponding center frequency. (Channel number is not needed because the cal factor frequencies are rounded to the nearest 500 MHz). The Cal Factor message in the display window will show ON if the Cal Factor command is sent properly to the sensor.
- Step 5. With no power applied to the sensor, press the **Zero** key to zero the sensor. This is recommended when making power measurements below -20 dBm.

Changing the scale of the Analog Display

- Step 6. Press the **Amplitude** key.
- Step 7. Press **Auto Scale** to align the needle in the middle of the analog display. The max and min values will align accordingly.
- Step 8. Press **Max** and use the key pad to manually set the maximum value of the analog display.
- Step 9. Press **Min** and use the key pad to manually set the minimum value of the analog display.

Using Attenuators

- Step 10. Press the **Amplitude** key and select Enter Offset
- Step 11. Enter the offset value for the attenuator at the frequency of operation.

Displaying Relative Power

- Step 12. Press the **Amplitude** key.
- Step 13. With the desired base power level input to the sensor, press the Relative soft key. The power reading will show 0 dB and 100%. If you are measuring a 10 dBm signal and the Relative key is selected, a drop to 7 dBm will show -3dB and 50%.

Averaging/Max Hold/Run Hold

- Step 14. Press the **Average** key.
- Step 15. Press the **Running Averages** key. Use the key pad to enter the number of averages you would like to use.
- Step 16. Press the **Max Hold** key to toggle between **Max Hold On** and **Max Hold Off**. If averaging is selected, the Max Hold will display the max value of the non-averaged data.

Limits

- Step 17. Press the **Limit** key.
- Step 18. Press the **Lower Limit** key. Enter the lower limit value in dBm or in Watts.
- Step 19. Press the **Upper Limit** key. Enter the upper limit value in dBm or in Watts.
- Step 20. Press the **Limit On/Off** key to turn the Limits on and off. The number display will turn green or red if the measurement is passing or failing.
- Step 21. Press the **Amplitude** and select **Units** to change between meters and feet.

Displaying Relative Power

- Step 22. Press the **Amplitude** key.
- Step 23. With the desired base power level input to the sensor, press the Relative soft key. The power reading will show 0 dB and 100%. If you are measuring a 10 dBm signal and the Relative key is selected, a drop to 7 dBm will show -3dB and 50%.

Saving the Measurement

- Step 24. Press the **File** key (Shift and File)
- Step 25. Press **Save**
- Step 26. Press **Save Measurement** and use the Text Entry soft keys to enter the desired file name.
- Step 27. Press **Save Screen as JPEG** to save the file as a JPEG.

Option 5 – External Power Monitor

Introduction

The External Power Monitor options measures broadband power using external sensors. These precision sensors are designed to minimize mismatch uncertainty. A wide range of precision sensors are available to support different connector types with upper frequency ranges from 3 GHz to 50 GHz. Display formats include absolute power (dBm or Watts) and relative power (dB or %). Auto averaging features reduces the effects of noise. Zeroing control allows optimum accuracy for low level signals. The measurement range for the 5400 and 560 series detector is -55 dBm to +16 dBm. All the Power Monitor features and specs are the same for all the handheld products.

Basics

This option is ideal if you need to measure the total power from a source including all harmonics, spurious outputs, etc (square law sensors will add the powers of all the signals within its passband). Since these are broadband measurements, external filtering would be needed to exclude signals at the input from the measured result. This option is particularly useful if you need to measure the output power of a microwave link, backhaul transmitter or a satellite signal.

The diode detector works very well for making average power measurements of CW signals and unmodulated RF carriers. If the RF carrier is being modulated, the average power can still be measured using the diode detector if the amplitude envelop is constant. Frequency Modulation (FM) signals can be measured using the diode detector because the amplitude envelope is fairly constant for FM. When measuring digitally modulated signals with non-constant amplitude envelopes, the diode needs to be in the square law region (< -25 dBm). The PSN50 sensor is a better solution for these types of measurements that require true RMS performance over a wide range.



Figure 9. Option 5 Power Measurement

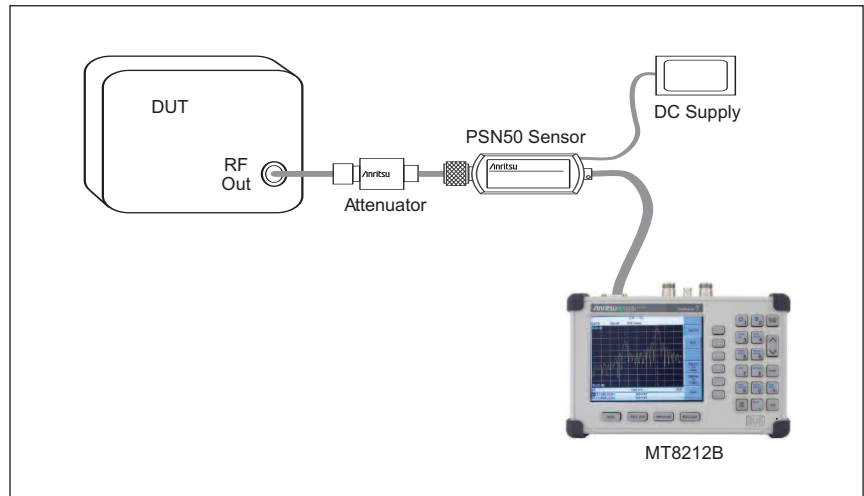

Figure 10. Power Monitor Setup

Power Monitor Procedure (S33XD, S8X0D, MT8212B, MS2711D)

- Step 1. Connect the power sensor to the RF detector port.
- Step 2. Press the **MODE** key
- Step 3. Select Power Monitor (External Detector)
- Step 4. Press the **AMPLITUDE** hard key. With nothing connected to the detector, press the Zero soft key.
- Step 5. Insert an attenuator between the DUT and the RF detector to protect the detector and to ensure that measurements are made within the specified measurement range (<+16 dBm)
- Step 6. Press **Offset** and enter the offset value of the attenuator
- Step 7. Measure the power

Power Monitor Procedure (MT8222A, MS202XA, MS203XA)

- Step1: Connect the power sensor to the RF detector port.
- Step2: Enter the **Mode** menu (Shift and 9) and select Power Monitor
- Step3: With no power applied to the DUT, press the Zero soft key.
- Step4: Insert an attenuator between the DUT and the RF detector to protect the detector and to ensure that measurements are made within the specified measurement range (<+16 dBm)
- Step5: Press **Offset** and enter the offset value of the attenuator.
- Step6: Measure the power

Estimated Uncertainty Curve for the 560-7N50B detector (CW signal) taking published detector SWR and flatness into account.

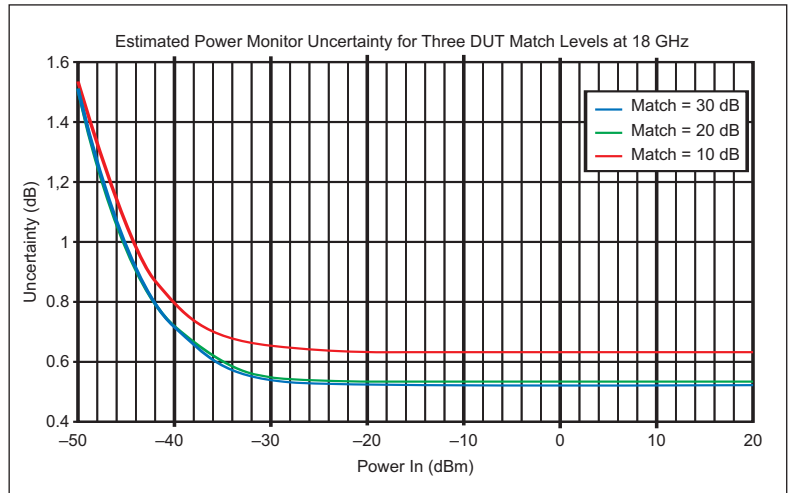

Figure 11. Uncertainty Curves for 560-7N50B sensor

Model	Frequency Range	Impedance	Return Loss	Input Connector	Frequency Response
560-7A50	0.01 to 18 GHz	50Ω	15 dB, <0.04 GHz 22 dB, <8 GHz 17 dB, <18 GHz	GPC-7	±0.5 dB, <3 GHz
560-7N50B	0.01 to 20 GHz	50Ω	15 dB, <0.04 GHz 22 dB, <8 GHz 17 dB, <18 GHz 14 dB, <20 GHz	N(m)	±0.5 dB, <18 GHz ±1.25 dB, <20 GHz
560-7S50B	0.01 to 20 GHz	50Ω	15 dB, <0.04 GHz 22 dB, <8 GHz 17 dB, <18 GHz 14 dB, <20 GHz	WSMA(m)	±0.5 dB, <18 GHz ±2.0 dB, <20 GHz
560-7S50	0.01 to 26.5 GHz	50Ω	16 dB, <0.04 GHz 22 dB, <8 GHz 17 dB, <18 GHz 14 dB, <26.5 GHz	WSMA(m)	±0.5 dB, <18 GHz ±2.0 dB, <26.5 GHz
560-7K50	0.01 to 40 GHz	50Ω	13 dB, <0.04 GHz 22 dB, <8 GHz 17 dB, <8 GHz 16 dB, <26.5 GHz 15 dB, <32 GHz 13 dB, <40 GHz	K(m)	±0.5 dB, <18 GHz ±1.25 dB, <26.5 GHz ±2.2 dB, <32 GHz ±2.5 dB, <40 GHz
560-7VA50	0.01 to 50 GHz	50Ω	19 dB, <20 GHz 15 dB, <40 GHz 10 dB, <50 GHz	V(m)	±0.5 dB, <18 GHz ±1.25 dB, <26.5 GHz ±2.5 dB, <40 GHz ±3.0 dB, <50 GHz

Table 1. Power Detectors compatible with option 5

Internal Power Meter

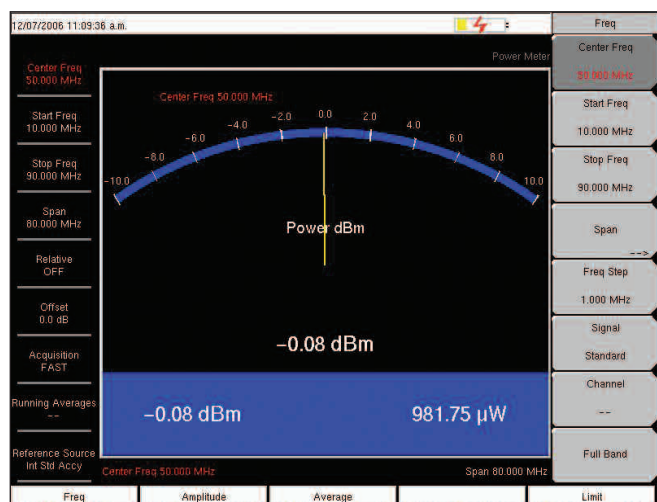

Figure 12. Power Meter Display (Super H platform)



Figure 13. Power Meter Display (Site Master Platform)

Introduction

The Internal Power Meter is available in some of the Super H platform products (MT8222A, MS272XB, MS20XA) and in the D platform (S33XD, MS2711D, MT8212B). It is a standard feature for the Cell Master and the BTS Master and available as an option (Option 29) for S332D and MS2711D. No external sensor is required for this option. The Spectrum Analyzer board and detection circuitry is used to provide users with frequency and channel selective power meter measurements.

Basics

If you have a need to do a power meter-style measurement over a limited frequency range, with a large, easy-to-read display, the internal power meter is the perfect choice. It is the only power meter solution that provides frequency selective power measurements. The Power Meter Measurement works for signals with both constant and non-constant amplitude envelopes over the entire measurement range. The published accuracy specifications apply for most complex modulation formats that are common today among different wireless technologies including CDMA, WCDMA/HSDPA, WiMAX, GSM/GPRS/EDGE.

You can set the frequency range manually either by entering the start frequency/stop frequency or the center frequency and the span. The Signal Standard List provides easy access for the most common signal standards used today. If a certain signal is not in the Signal Standard List, Handheld Software Tools or Master Software Tools can be used to edit the list and to add standards that are not available in the original list.

The offset of external cables and attenuators can be entered manually or kit 65701 can be used to perform an offset calibration (< 3 GHz) for users in need of better accuracy.

Both platforms can display units in dBm and Watts. The Super H products also display power in Volts.

Power Meter for the Site Master platform (S33XD, MT8212B, MS2711D)

The internal Power Meter frequency coverage for the Site Master platform products extends from 4.5 MHz to 3 GHz. The frequency span can be set from 3 MHz to 2997 MHz.

Offset Calibration

The offset calibration can be applied to the S33XD, MS2711D, and MT8212B products. It improves the accuracy of applications requiring external attenuators and cables.

Calibrate the Offset

- Step1: Press **MODE** and select **Power Meter**.
- Step2: Press **START CAL** (or press Amplitude -> Offset dB -> Recall Offset CAL)
- Step3: Connect the 10 dB pad to the RF Out connector. Connect a thru cable between RF In and the 10 dB pad and press **ENTER**.
- Step5: Add the 30 dB attenuator and phase stable cable assembly to be calibrated between the RF In port and the thru cable and press **ENTER**.
- Step6: Remove the thru cable and the 10 dB pad. Leave the 30 dB attenuator and the cable on the RF In port. The loss of the 30 dB attenuator and phase stable cable is automatically subtracted from the measurement.

Power Meter Procedure

- Step 1. Press the **MODE** key, select Power Meter (Internal) mode.
- Step 2. Press the **FREQ/DIST** key and select the **Signal Standard** soft key, now press **Select Standard** soft key. Select the appropriate standard.
- Step 3. Press **Select Channel** soft key and enter the appropriate channel #.
- Step 4. Press the **START CAL (#3)** key and perform the Offset Cal as outlined above (S332D and MT8212B).
- Step 5. Press **MEAS/DISP** key and select the **RMS Averaging** soft key.
- Step 6. Select **Medium Averaging**.



Figure 14. Offset Calibration

Power Meter for the Super H platform (MT8222A, MS2721A, MT8220A)

The internal Power Meter frequency coverage for the Super H platform products extends from 10 MHz to 7.1 GHz. The Max and Min values of the analog display can be adjusted in the Amplitude Menu. The scale of the analog display reflects the Unit selection. There are three selections for the Acquisition Speed: Fast, Med, or Slow. Running Averaging takes the linear average of up to 100 traces.

If you are looking to make Pass/Fail measurements and need clear indications whether or not the power is within the specified limits, the Limit feature in the Limit Menu is the ideal solution. The Bar on the bottom turns green if the measured power is within specs and turns red if the measured power is outside the limit range.

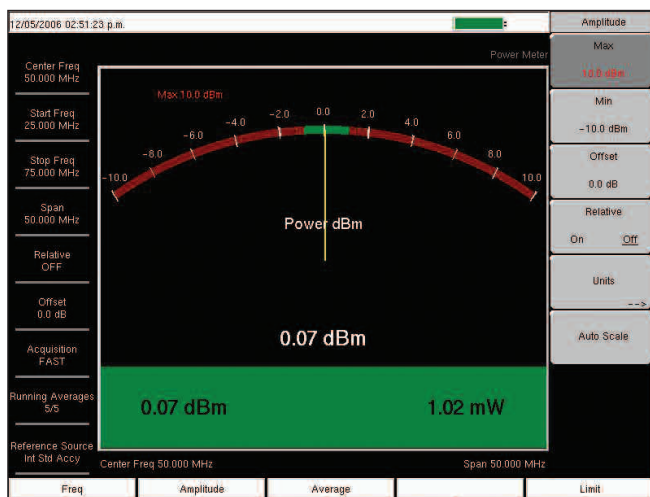

Figure 15. Limit Setup - PASS

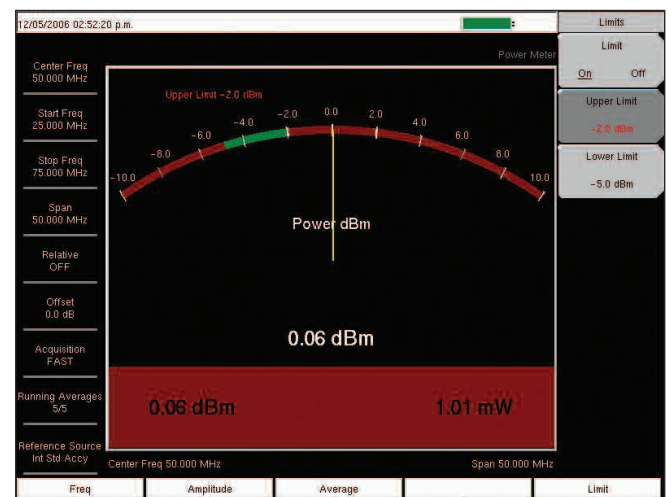

Figure 16. Limit Setup - FAIL

Power Meter Procedure (MT8222A, MT8220A)

- Step 1: Enter **Mode** menu (Shift and 9) and select **Power Meter**.
- Step 2: Press the **Freq** key and set the Start and Stop frequencies. Or select **Signal Standard** to find a standard in the list and select **Channel** to enter the channel number of the selected standard.
- Step 3: Press the **Average** key and set the Acquisition speed to Fast, Medium, or Slow.
- Step 4: Press the **Running Averages** key and enter the number of averages you would like to use. The number can be set between 1 and 100.
- Step 5: Press the **Limit** hard key and set the upper and lower limits.

Channel Power Measurement

Introduction

This smart spectrum analyzer measurement provides the ultimate in flexibility in setting up a power measurement. Because of this flexibility, the user needs to know the details of the signal being measured to be sure of setting the parameters correctly, especially for non-standard signal formats using new digital modulation formats.

Basics

When measuring channel power of non-standard signals, this measurement provides the best flexibility. The Cell Master has options and default settings for CDMA, GSM, and EV-DO. The BTS Master has default settings for WCDMA/HSDPA, GSM/GPRS/EDGE, and WiMAX. If you need to measure the RMS power of a signal that the instrument does not have default settings for, the channel power measurement is ideal since it allows you to change RBW/VBW, detection method, frequency range, number of averages, reference level, attenuator and preamp settings, and much more. Peak hold may be used during channel power measurements of frequency hopping transmitters (e.g 802.11b).

During the course of making a channel power measurement, red vertical lines are shown on the spectrum analyzer display that delineate the frequency range over which the power is being measured. Based on the spectrum analyzer display, the user can decide if changes in the measurement settings are needed. For example, it can be easily seen in figure 3, that the small signal slightly above the channel isn't included in the measurement. To smooth the measured result, trace averaging was used during this measurement. This is useful in situations such as this one where the signal is relatively weak with significant variations from sweep to sweep due to evanescent path loss variations.

The user can easily customize the channel power measurement settings to meet specific needs. In Figure 4, an FM broadcast transmitter is being measured. Because of the nature of frequency modulation, measuring power on one sweep can be misleading. In this situation, as is the situation with CDMA measurements, averaging several sweeps leads to a much more meaningful assessment of power.

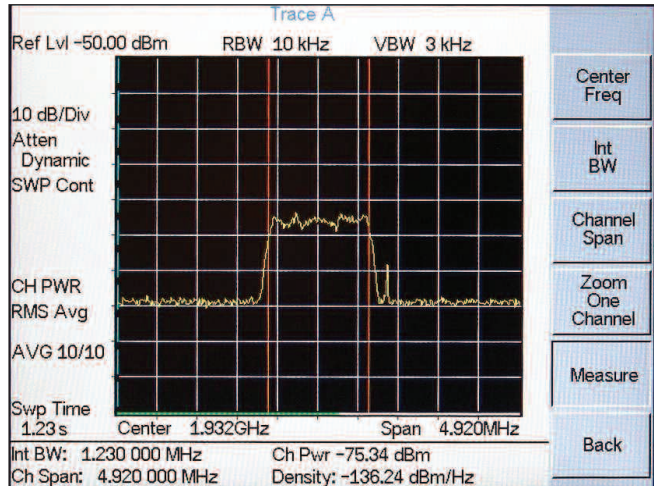

Figure 17. Channel Power Measurement

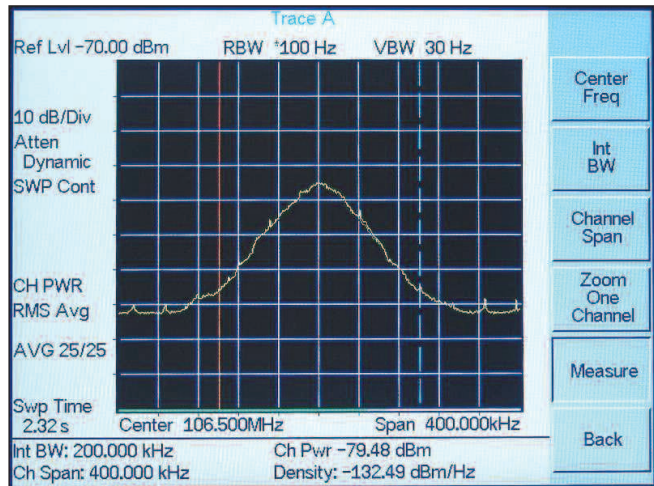

Figure 18. Channel Power of an FM Broadcast Transmitter

Channel Power Procedure (S33XD, MT8212B, MS2711D)

- Step 1: Press the Mode key and select Spectrum Analyzer
- Step 2: Set the frequency by setting the center frequency and span or press the Signal Standard Soft Key and select the standard and appropriate channel number from the list.
- Step 3: Press the **AMPLITUDE** key and select the Rel Level soft key to set the reference level.
- Step 4: Press the Atten/Preamp soft key and set the attenuation to an appropriate attenuation setting using automatic, manual, or dynamic.
- Step 5: Press the Preamp On/Off or Preamp auto key to activate the preamplifier manually or automatically.
- Step 6: Press the **MEAS/DISP** key and select the Bandwidth soft key to set the RBW and VBW to auto or manually enter the desired values.
- Step 7: To turn on Max/Hold, press the MEAS/DISP key, select Trace and press the Max/Hold soft key.
- Step 8: Press the MEAS/DISP hard key and select Measure and Channel Power
- Step 9: Select the Int BW soft key and enter the appropriate integration bandwidth.
- Step 10: Make the measurement by pressing the Measure soft key.

Channel Power Procedure (MT8222A, MS272XB, MS203XA)

- Step 1: Enter **Mode** menu (Shift and 9) and select **Spectrum Analyzer**.
- Step 2: Press the **Freq** hard key and set the frequency by entering the center frequency or press the Signal Standard soft key to select the standard from the list.
- Step 3: Press the **Amplitude** hard key and select Reference Level to set it.
- Step 4: Press the **BW** key and set RBW and VBW manually or set them to Auto.
- Step 5: Press the **Amplitude** hard key and set the attenuation to auto or set it manually.
- Step 6: Press the **Measure** (Shift Measure) key and select Channel Power
- Step 7: Press the Ch Pwr Width to enter the integration bandwidth.
- Step 8: Make the measurement by pressing the On/Off key.

Channel Scanner, Option 27

The channel scanner option gives the user another convenient way to view power. The focus of the measurements made with this option is on channelized communication systems such as cellular systems, land mobile systems, maritime communication systems and the like. In figure 5, signals are being measured in the FM broadcast band. By setting the channel width and channel spacing almost any sort of communications system can be viewed. Up to 20 channels can be viewed simultaneously. Each channel can be displayed in both frequency and channel number. When you use the Signal Standard to select a standard, the channel span is automatically setup according to the standard. Both the old and the new platform allow you to change the channel step size and the channel span. Both instruments can display the power level for all the channels in a graph format and in a text format.

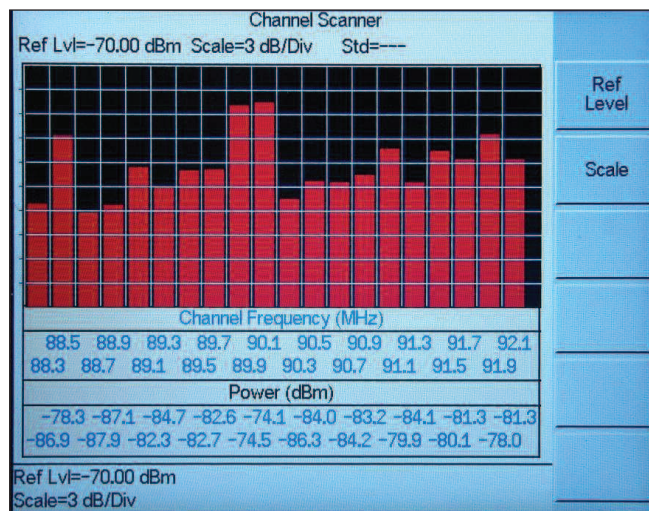

Figure 19. Channel Scanner in the D-platform

The channel scanner in the Super H products allows the user to customize each channel to display completely different signal types in each channel. For example, channel 1 could be a TV channel's video signal, channel 2 could be the TV channel's audio carrier, channel 3 could be CDMA US PCS channel 50, channel 4 could be GSM channel 600, channel 5 could be a nearby police repeater, channel 6 could be a ham repeater, etc.. If desired all 20 channels can be different. If the user is in a very dense RF environment with many emitters, the user could save several setups with different selections for each of the 20 channels to cover all the potentially interesting emitters.

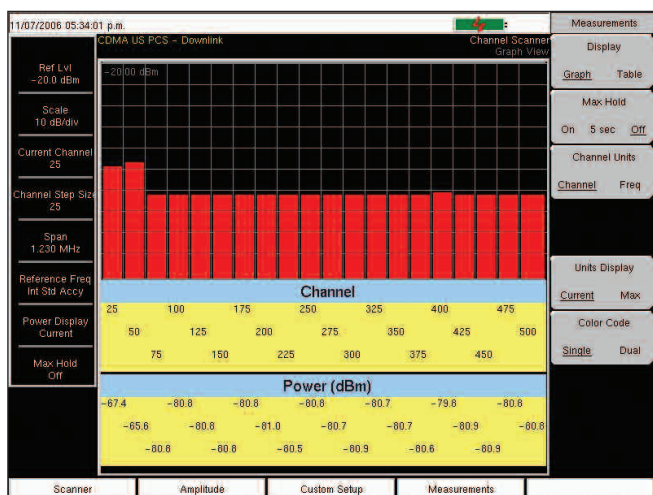

Figure 20. Scanning US PCS downlink using the Graph Format



Figure 21. US PCS downlink Table Format

Comparison

The following measurements were made with an MG3700 with the purpose of showing the different results for different modes. All the measurements were made with a 1.5 meter phase stable cable and the loss of the cable was taken out using the cable offset feature.

	0 dBm	-10 dBm EDGE burst 4 slots	-10 dBm EDGE burst 1 slot	WiMAX - 6 dBm 64 QAM	-10 dBm WCDMA
Super H Power Meter	0.05 dBm	-13.2 dBm	19.3 dBm	-6.07 dBm	-9.8 dBm
D Power Meter	-0.05 dBm	-13.2 dBm	-19.2 dBm	-6.15 dBm	-9.8 dBm
High Accuracy Power Meter	0.01 dBm	-13 dBm	-18.9 dBm	-5.97 dBm	-9.9 dBm
Power Monitor	0.2 dBm	-22 dBm	-25 dBm	-10 dBm	-5 dBm
GSM/EDGE/GPRS	N/A	-13.2 dBm	-19.3 dBm	N/A	N/A
WiMAX	N/A	N/A	N/A	-6.07 dBm	N/A
WCDMA	N/A	N/A	N/A	N/A	-9.8 dBm

Summary

Power measurements are not always that straight forward. Advances in the communications industry add complexity to the power measurement as the modulation formats used in today's system get more sophisticated. Anritsu's handheld products provide a wide range of solutions aimed at making the life easier for the technicians and RF Engineers in the field. The high accuracy power meter using the PSN50 sensor provides accurate measurements for both CW and modulated signals between 50 MHz and 6 GHz. If you need frequency selective power measurements, the channel power in the Spectrum Analyzer or the Internal Power Meter is recommended. For broadband CW power measurements, the Power Monitor provides coverage up to 50 GHz. The channel scanner offers convenient power measurements for applications where multiple or up to 20 channels can be viewed simultaneously.

Specifications

Internal Power Meter (MS2711D, S33XD, MT8212B)

Frequency Range: 3 MHz to 3.0 GHz
Measurement Range: -80 dBm to +20 dBm
Display Range: -80 dBm to +80 dBm
Offset Range: 0 to +60 dB
Accuracy***: ± 1 dB typical (± 1.5 dBm max), 10 MHz to 3 GHz
 ± 2 dB typical < 10 MHz
VSWR: 1.5:1 typical (Pin>-30 dBm, > 10 MHz to 2.4 GHz)
Maximum Power: +20 dBm without external attenuator
***excludes input VSWR

Internal Power Meter (MT8222A, MS272XB, MS203XA)

Frequency Range: 100 kHz to 7.1 GHz
Display Range: -80 dBm to +80 dBm
Measurement Range: -60 dBm to +30 dBm
Offset Range: 0 to +60 dB
Accuracy: -40 dBm <Max <=+15 dBm
10 MHz -4 GHz: ± 1.25 dB
4 GHz -7.1 GHz: ± 1.75 dB
Max > +15 dBm
10 MHz -6.5 GHz: ± 1.75 dB
6.5 GHz -7 GHz: ± 2 dB
Max <= -40 dBm
10 MHz -4 GHz: ± 1.5 dB
4 GHz -7.1 GHz: ± 1.75 dB
VSWR: 1.5:1 typical
Maximum Power: +30 dBm (1W) without external attenuator

Power Monitor (S33XD, MT8212B, MS2711D, MS202XA, MS203XA, S8X0D)

Detector Range: 1A peak to 150 ms, 300 mA max steady state
Offset Range: -50 to +20 dBm, 10 nW to 100 nW
Display Range: -80 to +80 dBm
Resolution: 0.1 dB
Measurement Accuracy: ± 1 dB maximum for > -40 dBm and < 18 GHz

High Accuracy Power Meter, PSN50 sensor (MT8222A, MS272XB, S33XD, MT8212B, MS2711D)

Measurement Range: -30 to +20 dBm
Frequency Range: 50 MHz to 6 GHz
Input Connector: Type N, male, 50W
Max Input Without Damage: +33 dBm, ± 25 VDC
Input Return Loss: 50 MHz to 2 GHz: ≥ 26 dB
2 GHz to 6 GHz: ≥ 20 dB
Accuracy:
Total RSS Measurement Uncertainty (0 to 50C): ± 0.16 dB*
Noise: 20 nW max
Zero Set: 20 nW
Zero Drift: 10nW max**
Sensor Linearity: ± 0.13 dB max
Instrumentation Accuracy: 0.00 dB
Sensor Cal Factor Uncertainty: ± 0.06 dB
Temperature Compensation: ± 0.06 dB max
Continuous digital modulation uncertainty: +0.06 dB (+17 to +20 dBm)
System:
Measurement Resolution: 0.01 dB
Offset Range: ± 60 dB
Interfaces
USB A/mini-B 2.0 (MT8222A, MS272XB)
RS-232 (S33XD, MT8212B, MS2711D)

Channel Scanner (MT8222A, MS272XB, MS203XA)

Frequency Range: 100 kHz to 7.1 GHz
Frequency Accuracy: ± 10 Hz + Time base error, 99% Confidence level
Measurement Range: +20 dBm to -110 dBm
Channel Power: 100 kHz to _10 MHz ± 1.5 dB
>10 MHz to 4 GHz ± 1.25 dB
>4 GHz to 7.1 GHz ± 1.75 dB
Adjacent Channel Power Accuracy: ± 0.75 dBc

Channel Scanner (S332D, MT8212B, MS2711D)

Frequency Range: 100 kHz to 3.0 GHz
Frequency Accuracy: ± 10 Hz + Time base error, 99% Confidence level
Measurement Range: +20 dBm to -110 dBm
Channel Power: ± 1 dB typical (± 1.5 dB max)
Adjacent Channel Power Accuracy: ± 0.75 dBc

* Excludes mismatch errors.

Excludes noise, zero set, zero drift for levels <-20 dBm.

Excludes digital modulation uncertainty between +17 and +20 dBm.

** After 30 min warm-up



ANRITSU Corporation

5-1-1 Onna, Atsugi-shi, Kanagawa, 243-8555 Japan
Phone: +81-46-223-1111
Fax: +81-46-296-1264

- U.S.A.

ANRITSU Company

1155 East Collins Boulevard, Suite 100
Richardson, Texas 75081
Toll Free: 1-800-ANRITSU (267-4878)
Phone: +1-972-644-1777
Fax: +1-972-671-1877

- Canada

ANRITSU Electronics Ltd.

700 Silver Seven Road, Suite 120, Kanata,
Ontario K2V 1C3, Canada
Phone: +1-613-591-2003
Fax: +1-613-591-1006

- Brazil

ANRITSU Eletrônica Ltda.

Praca Amadeu Amaral, 27-1 andar
01327-010 - Paraiso, São Paulo, Brazil
Phone: +55-11-3283-2511
Fax: +55-11-3886940

- U.K.

ANRITSU EMEA Ltd.

200 Capability Green, Luton, Bedfordshire LU1 3LU, U.K.
Phone: +44-1582-433280
Fax: +44-1582-731303

- France

ANRITSU S.A.

9, Avenue du Québec Z.A. de Courtaboeuf
91951 Les Ulis Cedex, France
Phone: +33-1-60-92-15-50
Fax: +33-1-64-46-10-65

- Germany

ANRITSU GmbH

Nemetschek Haus, Konrad-Zuse-Platz 1
81829 München, Germany
Phone: +49 (0) 89 442308-0
Fax: +49 (0) 89 442308-55

- Italy

ANRITSU S.p.A.

Via Elio Vittorini, 129, 00144 Roma, Italy
Phone: +39-06-509-9711
Fax: +39-06-502-2425

- Sweden

ANRITSU AB

Borgafjordsgatan 13, 164 40 Kista, Sweden
Phone: +46-8-534-707-00
Fax: +46-8-534-707-30

- Finland

ANRITSU AB

Teknobulevardi 3-5, FI-01530 Vantaa, Finland
Phone: +358-20-741-8100
Fax: +358-20-741-8111

- Denmark

ANRITSU A/S

Kirkebjerg Allé 90 DK-2605 Brøndby, Denmark
Phone: +45-72112200
Fax: +45-72112210

- Spain

Anritsu EMEA Ltd.

Oficina de Representación en España

Edificio Veganova
Avda de la Vega, nº 1 (edf 8, pl1, of 8)
28108 ALCOBENDAS - Madrid, Spain
Phone: +34-914905761
Fax: +34-914905762

- United Arab Emirates

ANRITSU EMEA Ltd.

Dubai Liaison Office

P O Box 500413 - Dubai Internet City
Al Thuraya Building, Tower 1, Suit 701, 7th Floor
Dubai, United Arab Emirates
Phone: +971-4-3670352
Fax: +971-4-3688460

- Singapore

ANRITSU Pte Ltd.

10, Hoe Chiang Road #07-01/02, Keppel Towers,
Singapore 089315
Phone: +65-6282-2400
Fax: +65-6282-2533

- P. R. China (Hong Kong)

ANRITSU Company Ltd.

Suite 923, 9/F., Chinachem Golden Plaza, 77 Mody Road,
Tsimshatsui East, Kowloon, Hong Kong, P.R. China
Phone: +852-2301-4980
Fax: +852-2301-3545

- P. R. China (Beijing)

ANRITSU Company Ltd.

Beijing Representative Office

Room 1515, Beijing Fortune Building,
No. 5, Dong-San-Huan Bei Road,
Chao-Yang District, Beijing 100004, P.R. China
Phone: +86-10-6590-9230
Fax: +82-10-6590-9235

- Korea

ANRITSU Corporation, Ltd.

8F Hyunjuk Bldg. 832-41, Yeoksam-Dong,
Kangnam-ku, Seoul, 135-080, Korea
Phone: +82-2-553-6603
Fax: +82-2-553-6604

- Australia

ANRITSU Pty Ltd.

Unit 21/170 Ferntree Gully Road, Notting Hill
Victoria, 3168, Australia
Phone: +61-3-9558-8177
Fax: +61-3-9558-8255

- Taiwan

ANRITSU Company Inc.

7F, No. 316, Sec. 1, Neihu Rd., Taipei 114, Taiwan
Phone: +886-2-8751-1816
Fax: +886-2-8751-1817

- India

ANRITSU Corporation

India Liaison Office

Unit No.S-3, Second Floor, Esteem Red Cross Bhavan,
No.26, Race Course Road, Bangalore 560 001 India
Phone: +91-80-32944707
Fax: +91-80-22356648

